

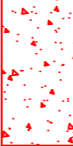





Pavimentazione

-  Scarifica asfalto esistente
-  Allargamento campo in asfalto

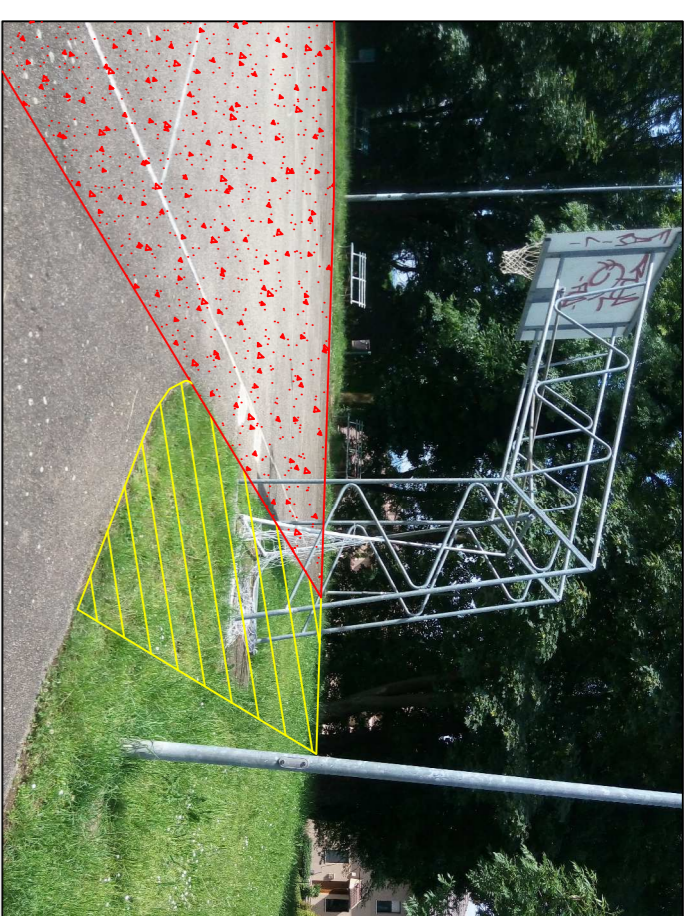
1



Muretto perimetrale

-  Spicconatura intonaci ammorati, sistemazione delle murature e rifacimento dell'intonaco

2

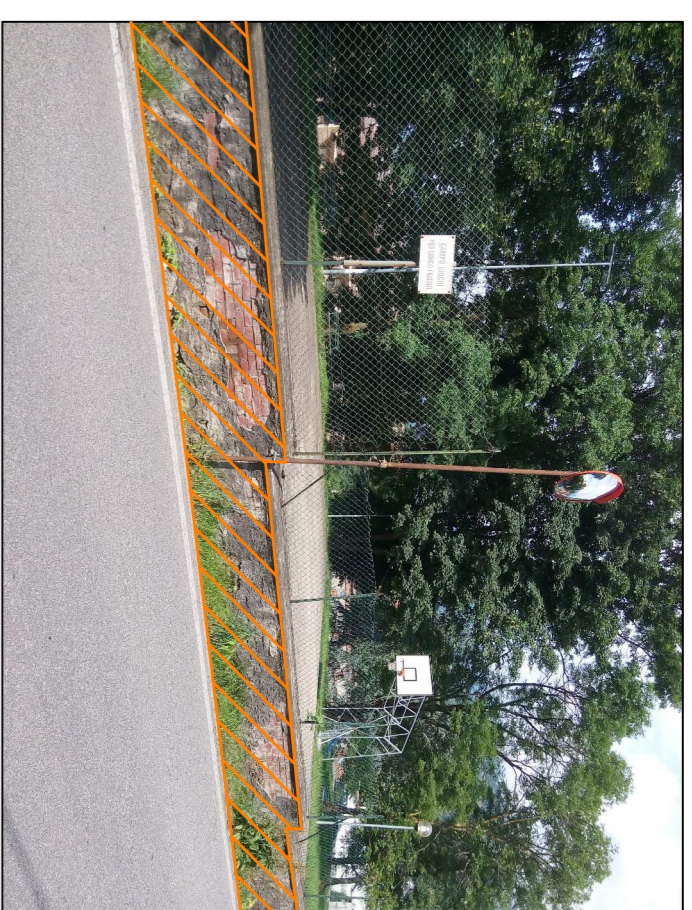



Colorazione

Realizzazione campo da basket in acrilico, resistente agli agenti atmosferici, applicato su sottofondo in asfalto con pendenze variabili per il deflusso delle acque piovane.

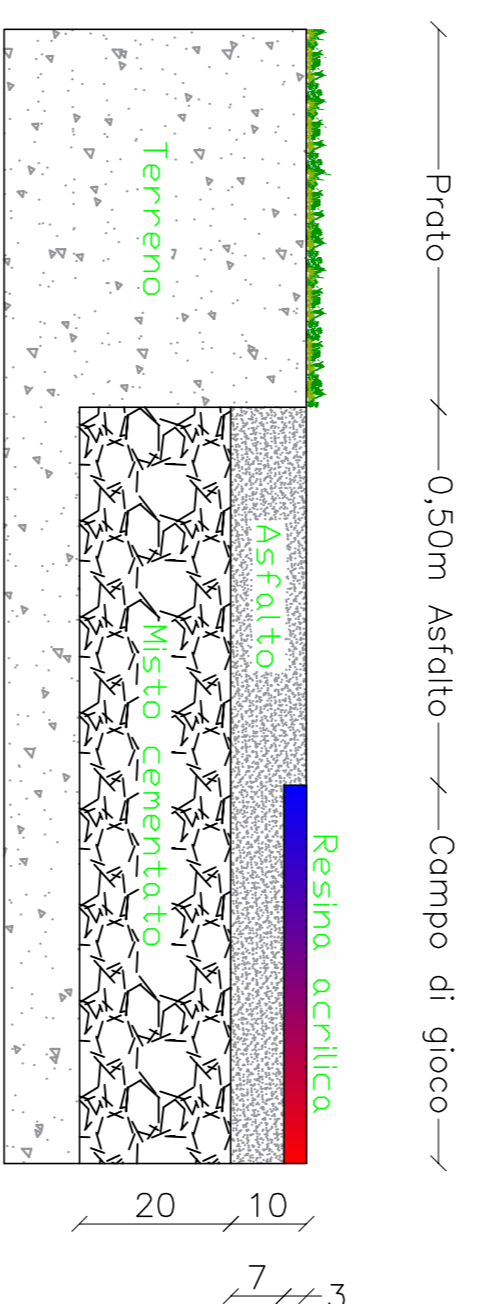
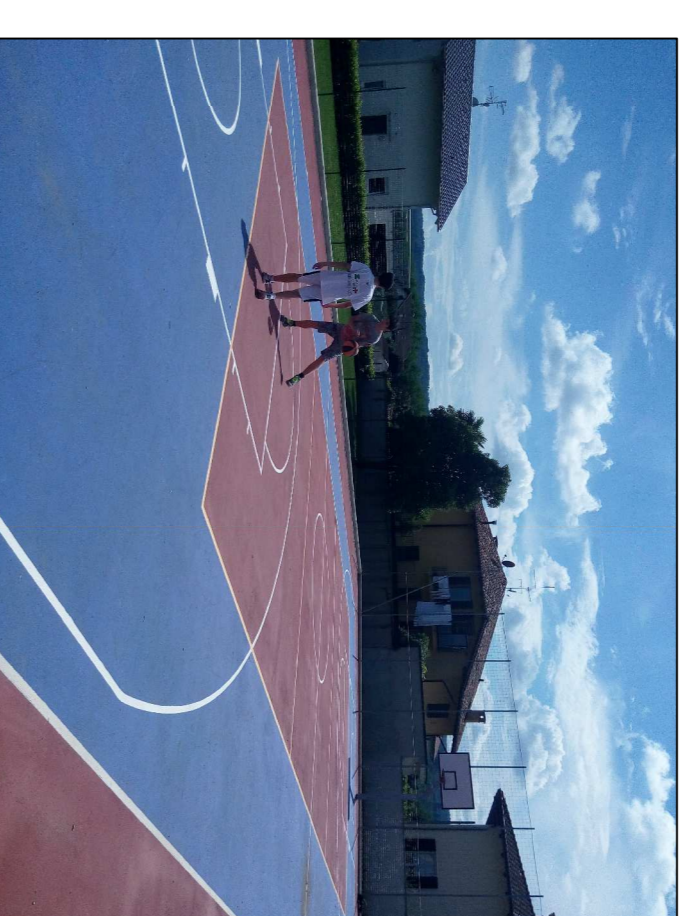
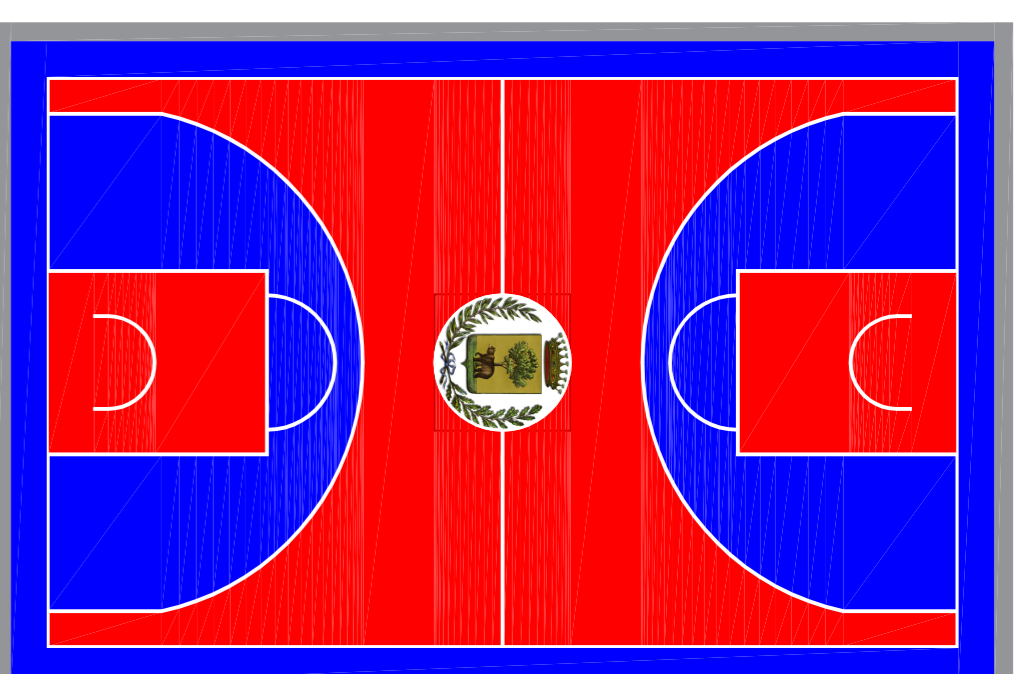
3



Potature e Abbattimenti

-  Alberi da potare
-  Alberi da abbattere

4

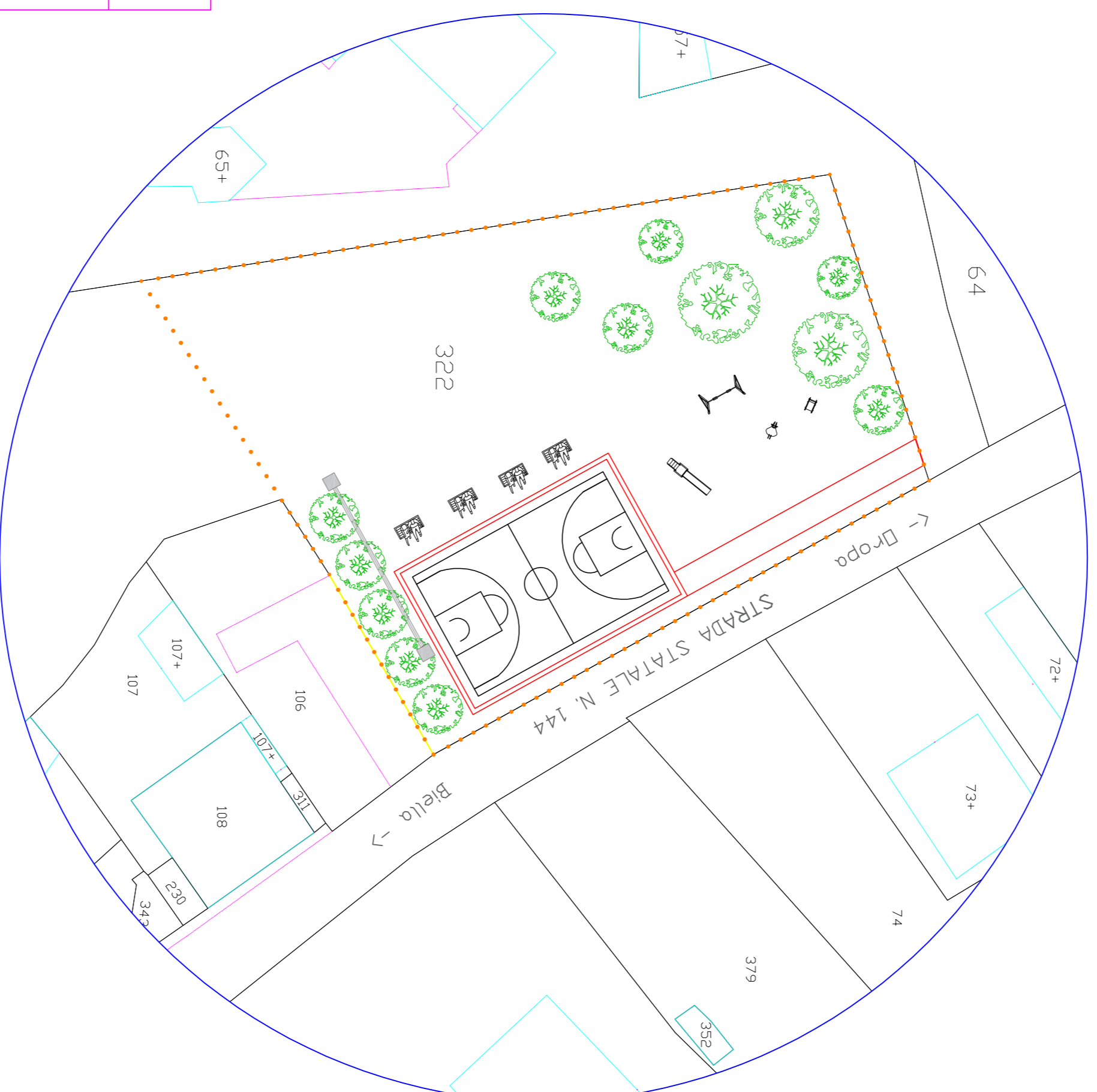

Rete di recinzione

Riposizionamento di rete a maglia romboidale di altezza pari a 2,00 m e filo zincato e plastificato di colore verde. Rete ad alta resistenza appositamente realizzata per le recinzioni di impianti sportivi.

5

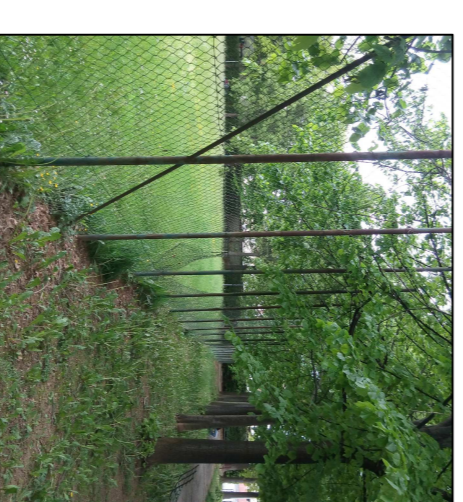

Raccolta acque meteoriche

Realizzazione di pozzetto a perdere in calcestruzzo prefabbricato collegato a punto di raccolta acque meteoriche fianco conestivo lato sud

6

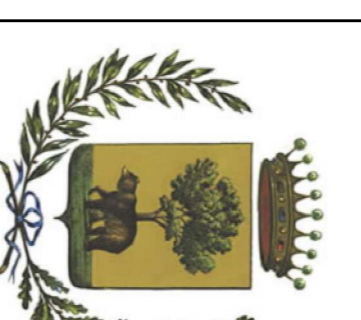
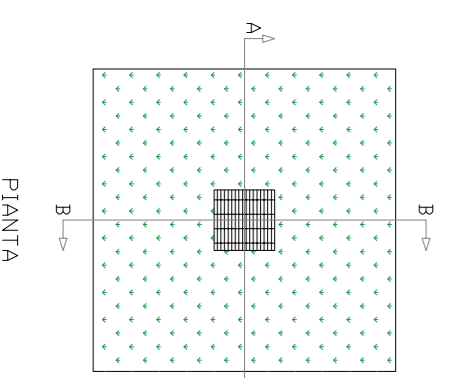
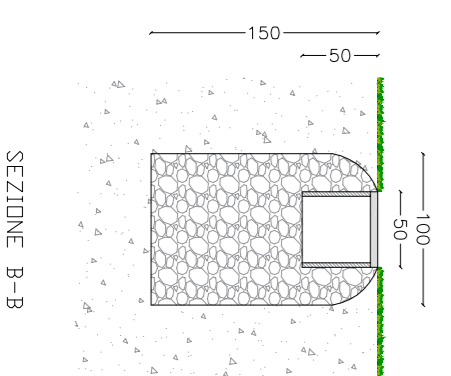
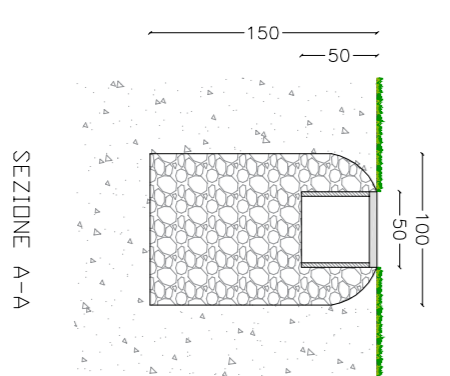

CITTÀ di BIELLA
 MERGOLA D'ORO AL VALORE MILITARE
 UFFICIO ARREDO - PARCHI e GIARDINI
 Progetto esecutivo



INTERVENTI DIVERSI DI ADEGUAMENTO AREE GIOCO ALL'APERTO

Cossila San Grato - Parco Frassati

ELABORATI: Planimetria generale, Documentazione fotografica Particolari e rendering

PROGETTISTA: Arch. Raffaella Penna
 RUP: Arch. Graziano Paternani
 PSC: Arch. Marco Siletti
 Collaboratore ed Esecutore: Geom. Antonio Pascuddu

Scale: Variabile
 Data: Settembre 2016
 Elaborato n° 1

AGGIORNAMENTI: